

Vitaliy Yatsenko

The first, system science approach provides accurate forecasts of electron fluxes but is limited to regions in which continuous data are available, i.e. GEO. The second, based on physical principles, provides good coverage throughout the whole inner magnetosphere but with significantly lower accuracy. The third, based on new tools for modeling and system identification to prediction of risk using optimization methods. The combination of three approaches, as used in the SNB3GEO electron flux model (which combines the data driven NARMAX and physical VERB models), can overcome many of the shortcomings of the two individual models, generating improved short term forecasts for the whole RB region. Long term RB forecast require the estimation of solar wind parameters at L1 based on remote solar observations.

Dynamical-information forecasting of geomagnetic indexes

Magnetosphere is considered as a nonlinear complex dynamical system

Kp,AE,Dst indexes

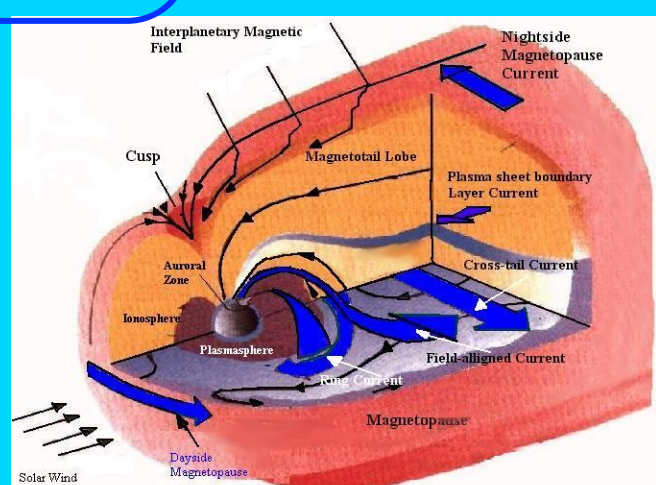

Dst is sought for as an output of a nonlinear dynamical "black-box"

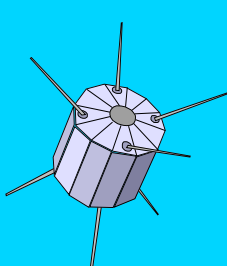

Data are from OMNI2 database:
<http://nssdc.gsfc.nasa.gov/omniweb/>
and Kyoto WDC for Geomagnetism:
<http://swdcdb.kugi.kyoto-u.ac.jp/>

Mathematical models

The **Guaranteed NARMAX Model (GNM)** provides predictions of the Dst index. Its main advantage is that it delivers an increased prediction reliability in comparison to earlier SRI models.

Guaranteed prediction of geomagnetic indexes

Algorithms and software

- Algorithms and software for optimal structure and parameters identification of mathematical models of ionizing radiation have been considered.
- Forecasting mathematical models of ionizing radiation by numerical methods has been tested

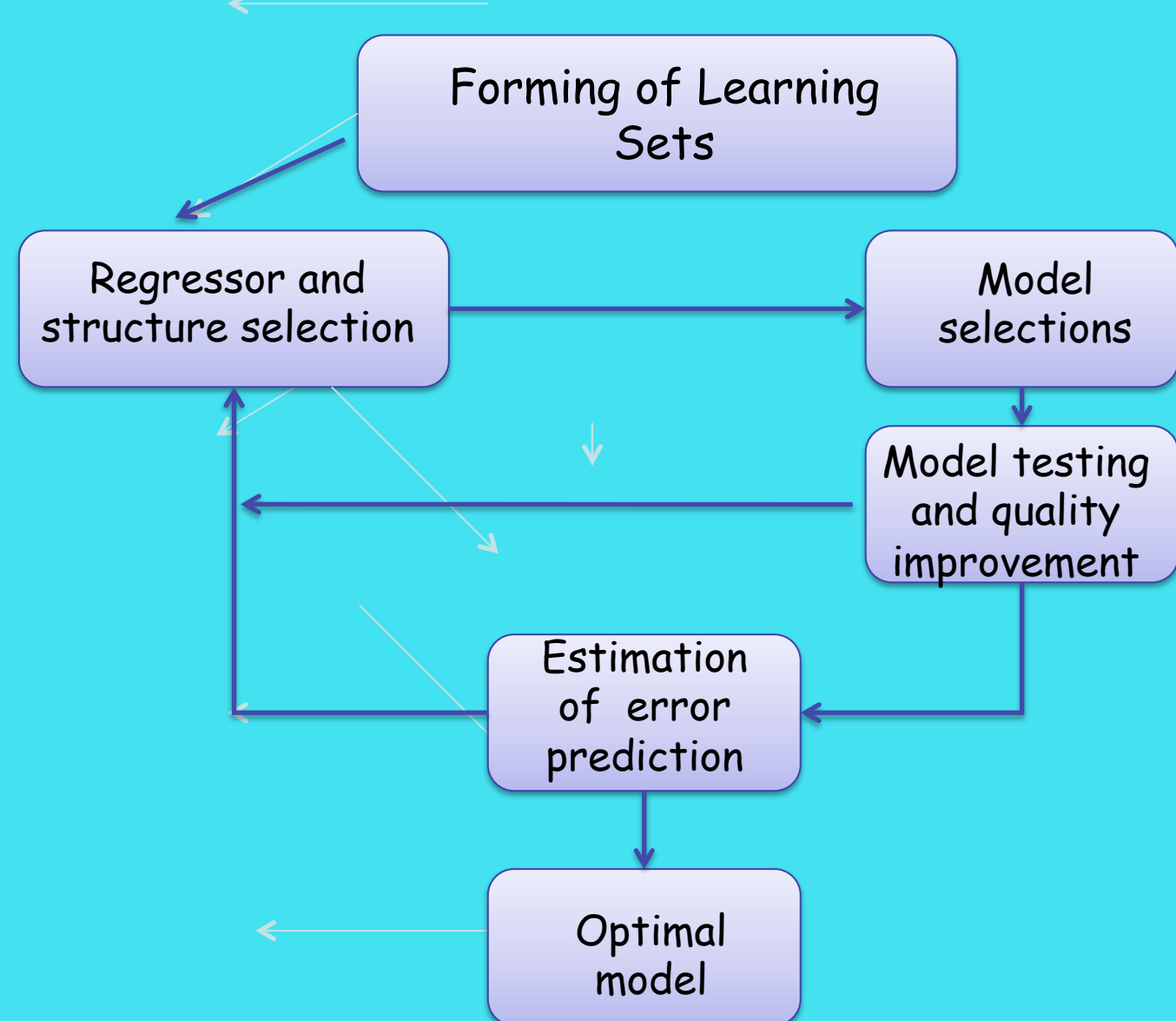

Fig. 1

Risk analysis

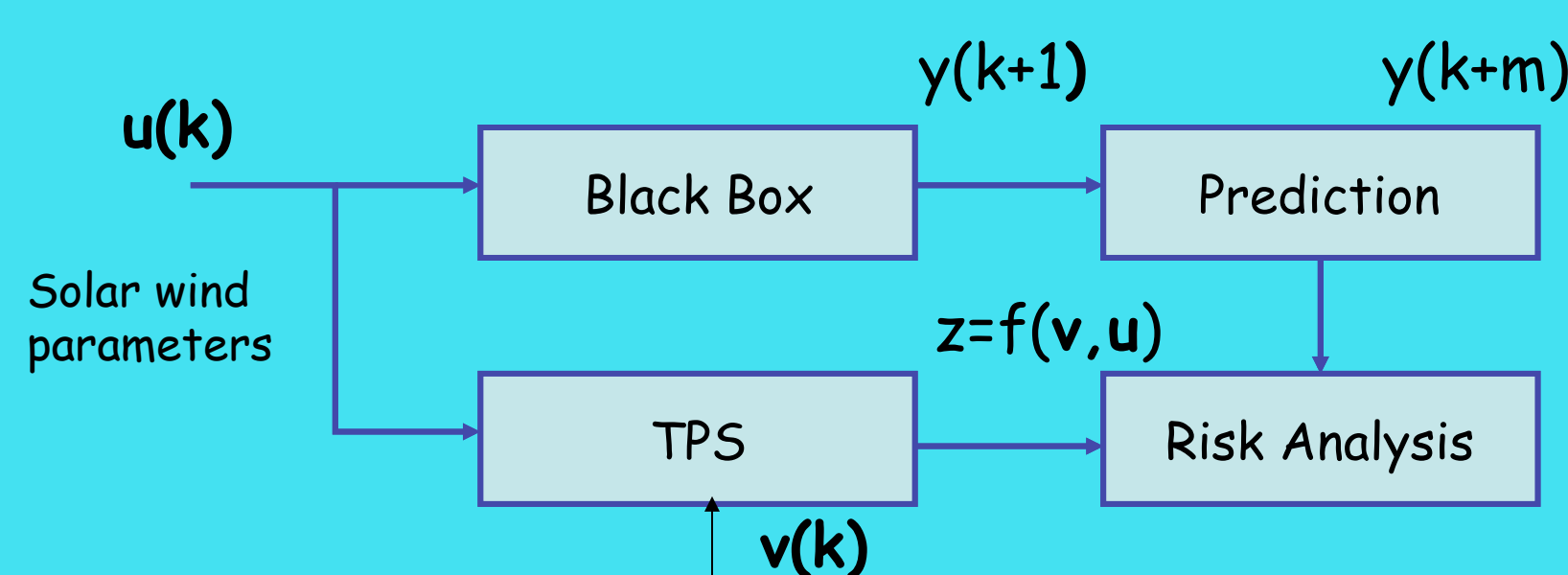

Fig. 2 Prediction and Risk Analysis

Optimization problem with constraints on risk

Let $z=f(v,u)$ be a loss function of a device depending upon the control vector v and a random vector u . The control vector v belongs to a feasible set V , satisfying imposed requirements. We assume that the random vector u has a probability density $p(u)$. We can define a function

$$\Phi_{\beta}(v, \beta) = (\alpha - \beta)^{-1} \int_{f(v,u) > \alpha} (f(v,u) - \alpha) p(u) du.$$

Optimization model

$$\min \mu(v)$$

$$v \in V, \Phi_{\beta}(x) \leq C_{\beta}, \Phi_{\gamma}(x) \leq C_{\gamma}.$$

Hybrid energy storage system based on supercapacitors

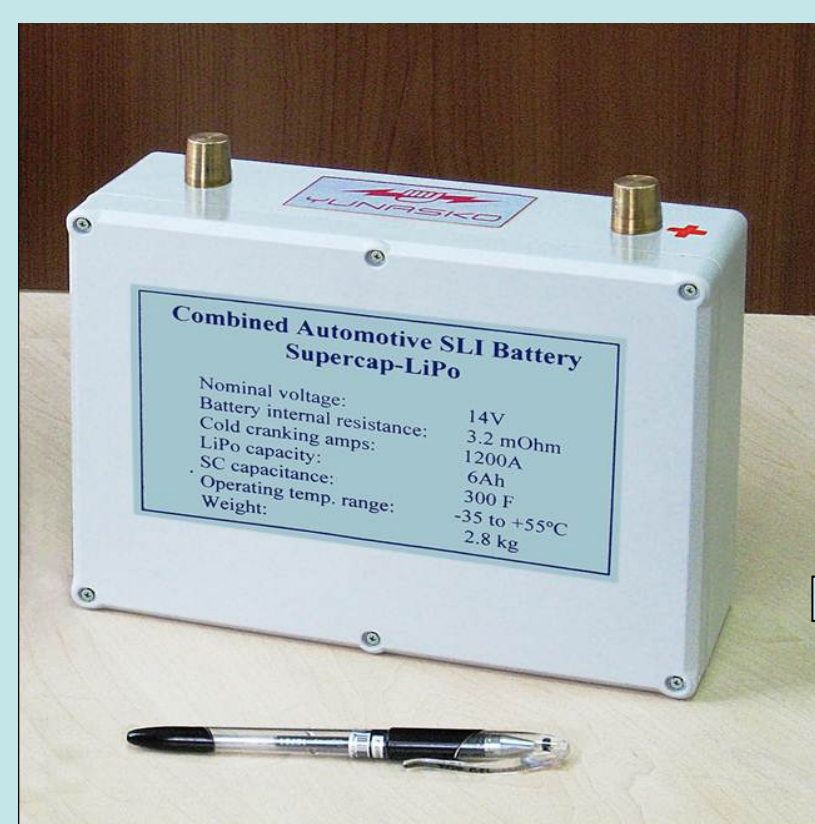

Fig. 3

Voltage decreases of supercapacitors before and after γ -irradiation

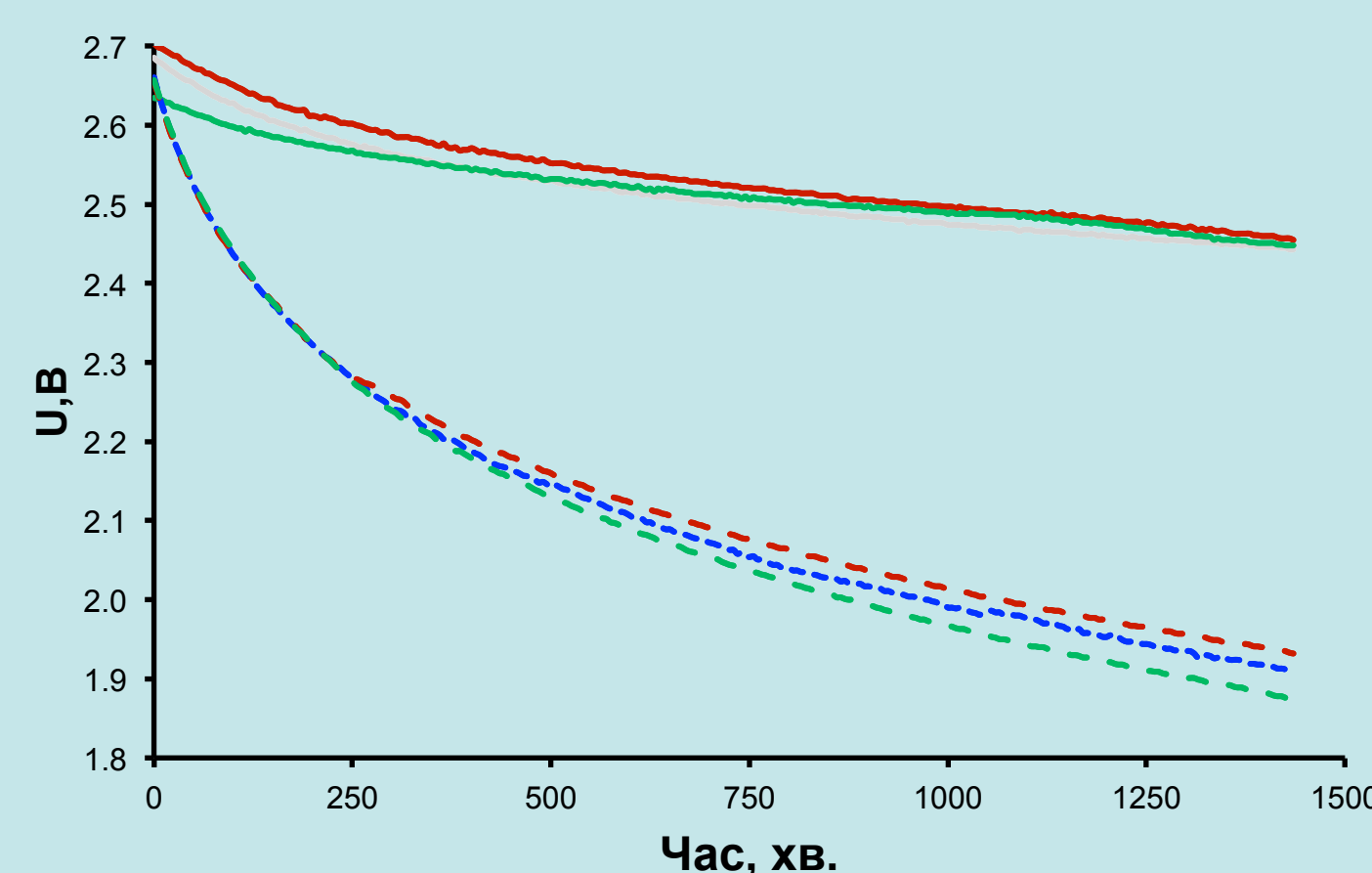

Fig. 4

Output of the diode laser after irradiation by gamma radiation

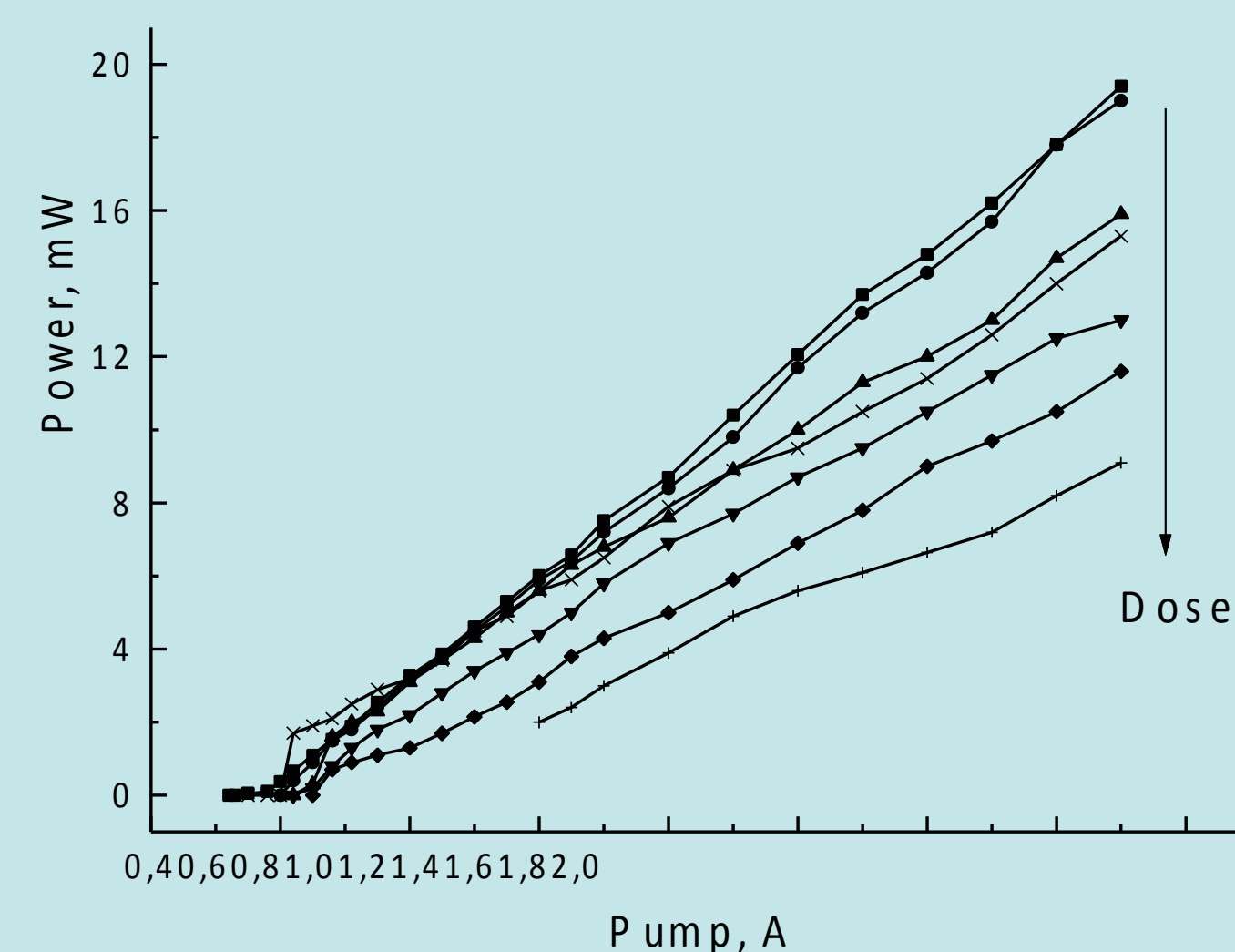

Fig. 5

Fig. 1