

Space Weather Influence on Power Systems: Prediction, Risk Analysis, and Modeling

Vitaliy Yatsenko

Space Research Institute of NASU-SSAU,

Kiev, Ukraine

vyatsenko@gmail.com

PROGRESS, a new Horizon 2020 funded project

EGU2016-6145, EGU General Assembly 2016

Abstract

- **This report concentrates on dynamic probabilistic risk analysis of optical elements for complex characterization of damages using physical model of solid state lasers and predictable level of ionizing radiation and space weather.**
- **The following main subjects will be covered by our report: (a) solid-state laser model; (b) mathematical models for dynamic probabilistic risk assessment; and (c) software for modeling and prediction of ionizing radiation.**

Methods

- This report concentrates on dynamic probabilistic risk analysis of optical elements for complex characterization of damages using physical model of solid state lasers and predictable level of ionizing radiation and space weather.
- The following main subjects will be covered by our report: (a) solid-state laser model; (b) mathematical models for dynamic probabilistic risk assessment; and (c) software for modeling and prediction of ionizing radiation.

Approach

We propose to use a new dynamical-information approach for radiation damage risk assessment of laser elements by cosmic radiation. Our approach includes the following steps: laser modeling, modeling of ionizing radiation influences on laser elements, probabilistic risk assessment methods, and risk minimization. For computer simulation of damage processes at microscopic and macroscopic levels the following methods are used: (a) statistical; (b) dynamical; (c) optimization; (d) acceleration modeling, and (e) mathematical modeling of laser functioning.

Dynamical-information forecasting of geomagnetic indexes

Magnetosphere is considered as a nonlinear complex dynamical system

Kp, AE, Dst indexes



Solar wind parameters

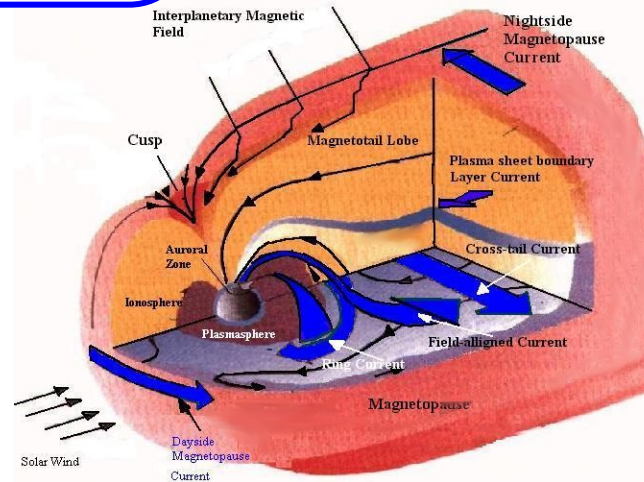

Dst is sought for as an output of a nonlinear dynamical "black-box"

Data are from OMNI2 database:
<http://nssdc.gsfc.nasa.gov/omniweb/>
and Kyoto WDC for Geomagnetism:
<http://swdcdb.kugi.kyoto-u.ac.jp/>

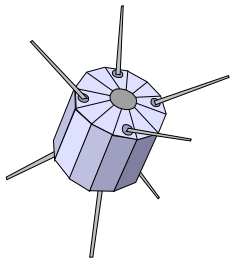

Mathematical models

- **Mathematical models of space ionizing radiation influence on laser elements were developed for risk assessment in laser safety analysis. This is a so-called ‘black box’ or ‘input-output’ models, which seeks only to reproduce the behaviour of the system’s output in response to changes in its inputs.**
- **The model inputs are radiation influences on laser systems and output parameters are dynamical characteristics of the solid laser.**

Mathematical models

- The **Guaranteed NARMAX Model (GNM)** provides predictions of the Dst index. Its main advantage is that it delivers an increased prediction reliability in comparison to earlier SRI models.
- **Guaranteed prediction** of geomagnetic indexes

Algorithms and software

- Algorithms and software for optimal structure and parameters identification of mathematical models of ionizing radiation have been considered.
- Forecasting mathematical models of ionizing radiation by numerical methods has been tested

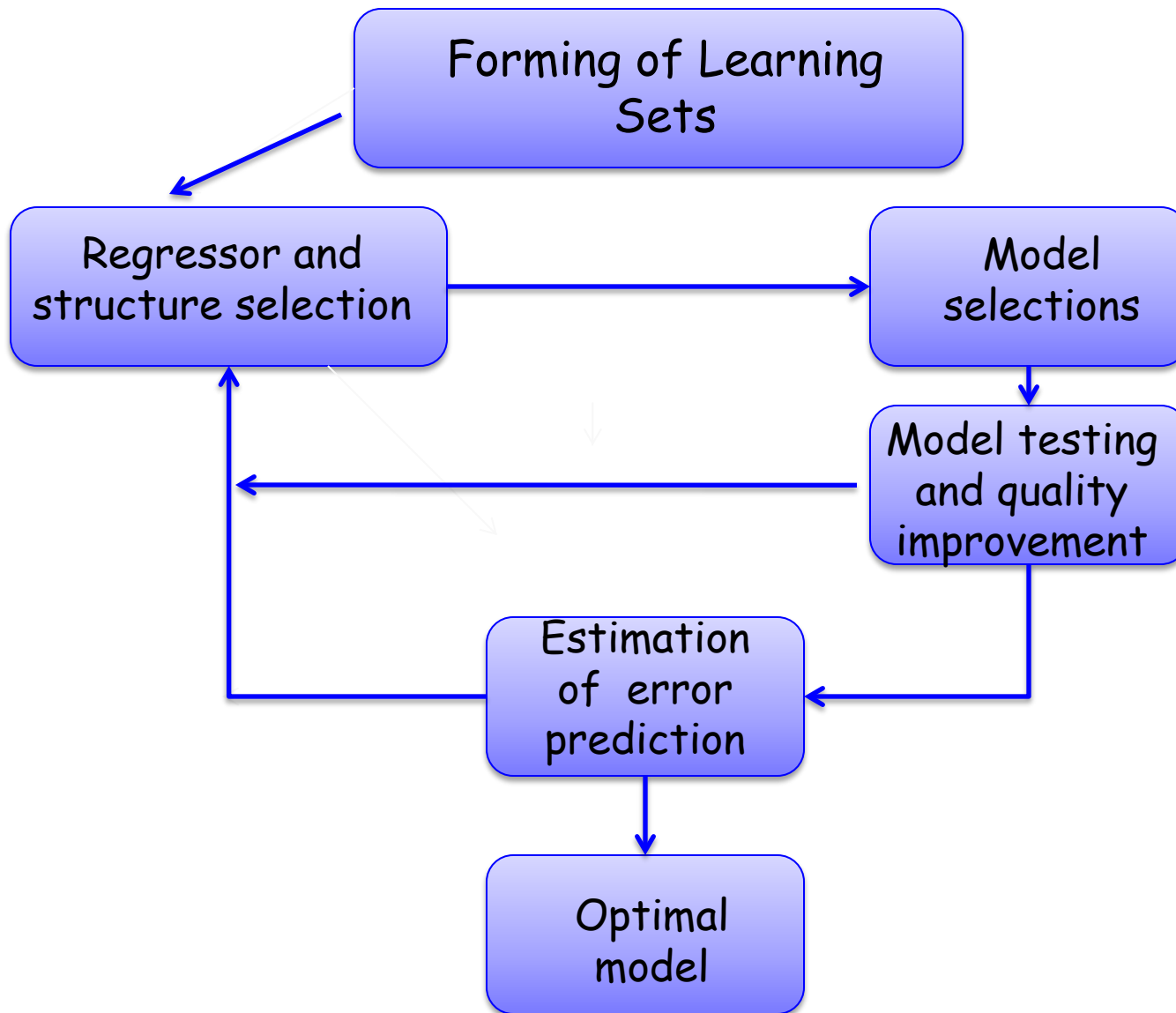

Fig. 1

Risk analysis

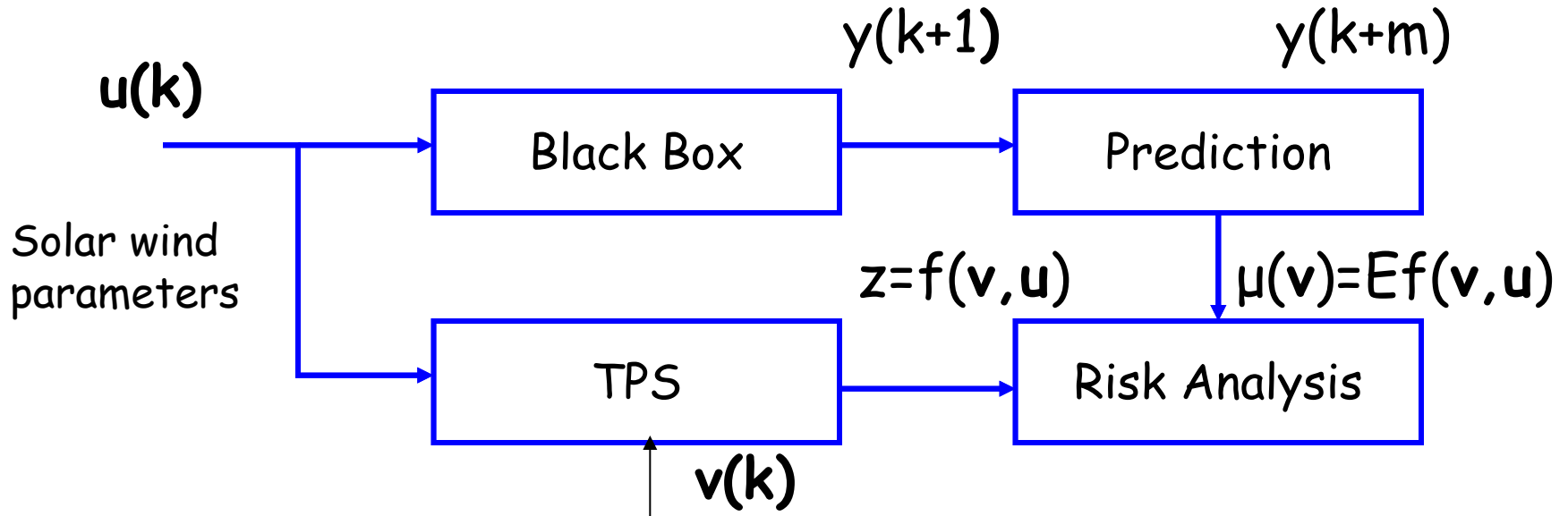

Fig. 2 Prediction and Risk Analysis

Optimization problem with constraints on risk

Let $z=f(v,u)$ be a loss function of a device depending upon the control vector v and a random vector u . The control vector v belongs to a feasible set V , satisfying imposed requirements. We assume that the random vector u has a probability density $p(u)$. We can define a function

$$\Phi_{\beta}(v, \beta) = (\alpha - \beta)^{-1} \int_{f(v,u) > \alpha} (f(v, u) - \alpha) p(u) du.$$

Optimization model

$$\min \mu(v)$$

$$v \in V, \Phi_{\beta}(x) \leq C_{\beta}, \Phi_{\gamma}(x) \leq C_{\gamma}.$$

Applications

- TPS (thermal protection system)
- Hybrid energy storage device based on supercapacitors
- Space accelerometers
- Superconducting gravimeter
- Lasers

Applications

Hybrid energy storage system based on supercapacitors

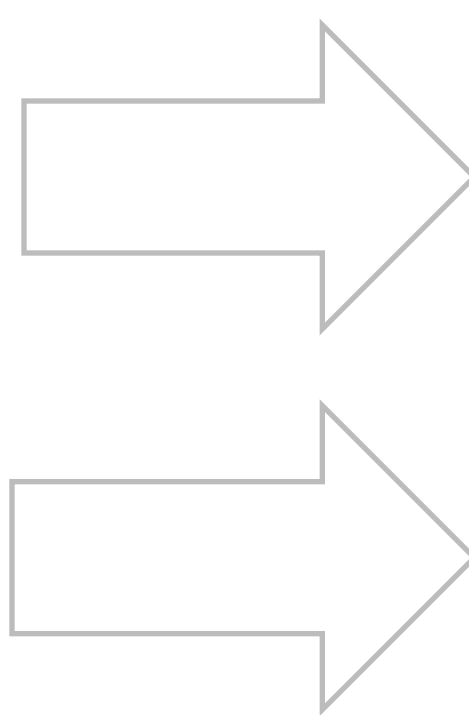

P, кВт

E, Вт·год

Fig. 3

Impact γ -irradiation on capacity of hybrid energy storage device

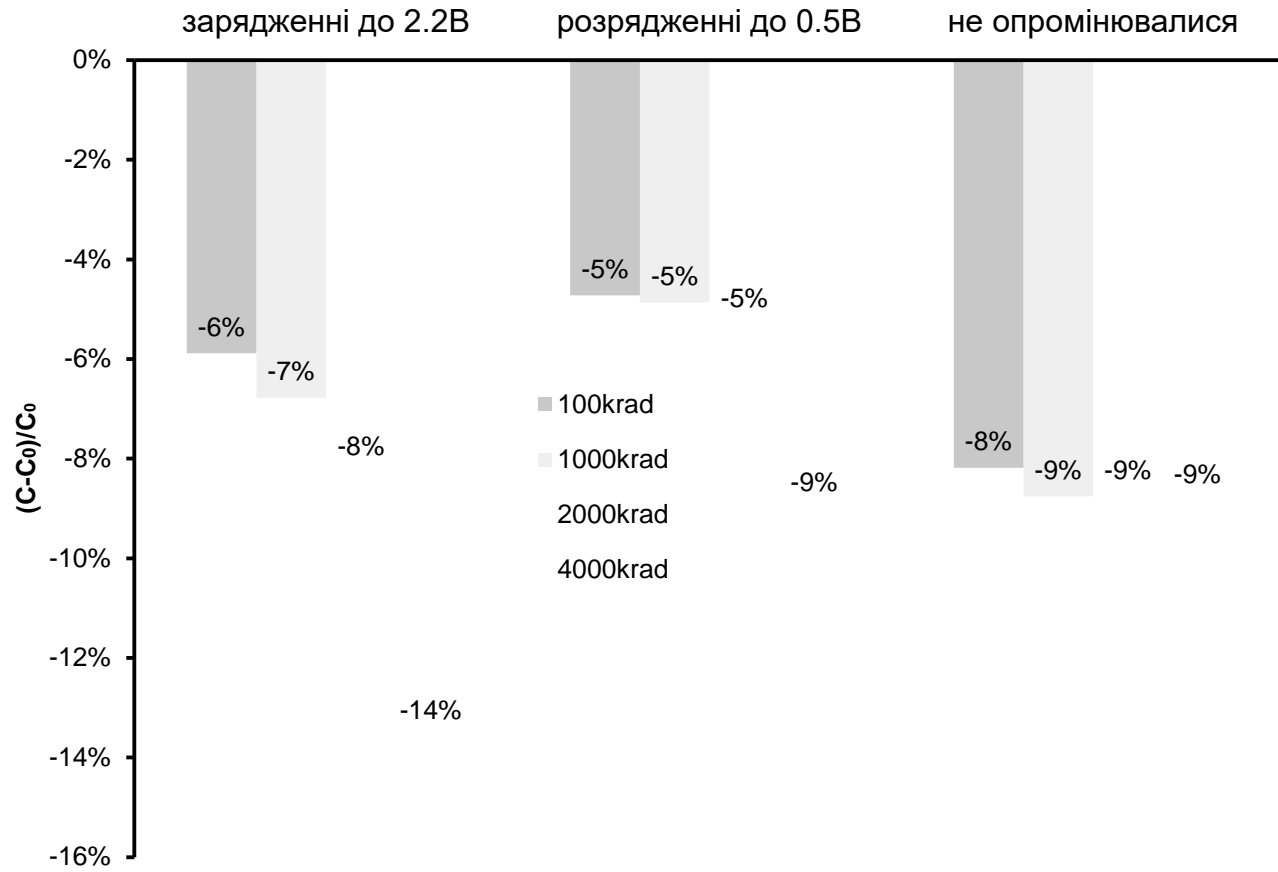

Fig. 4

Resistance increase by γ -irradiation of hybrid energy storage device

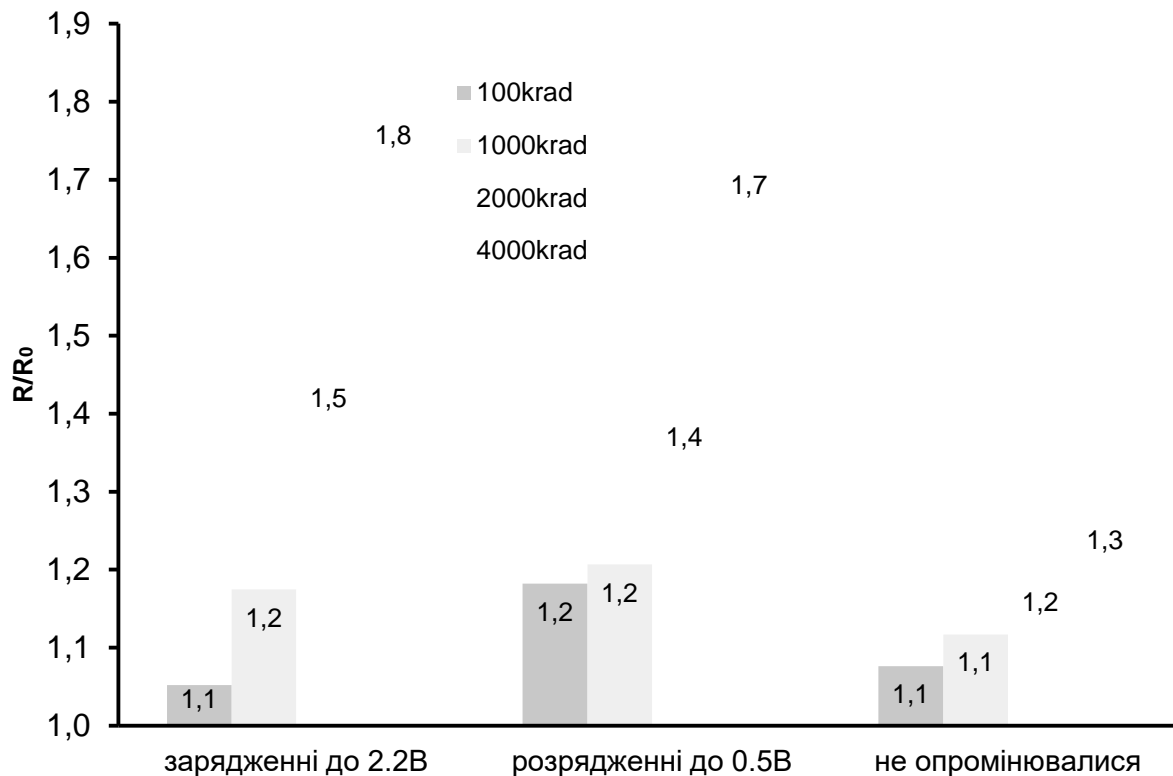

Fig. 5

Voltage decreases of supercapacitors before and after γ -irradiation

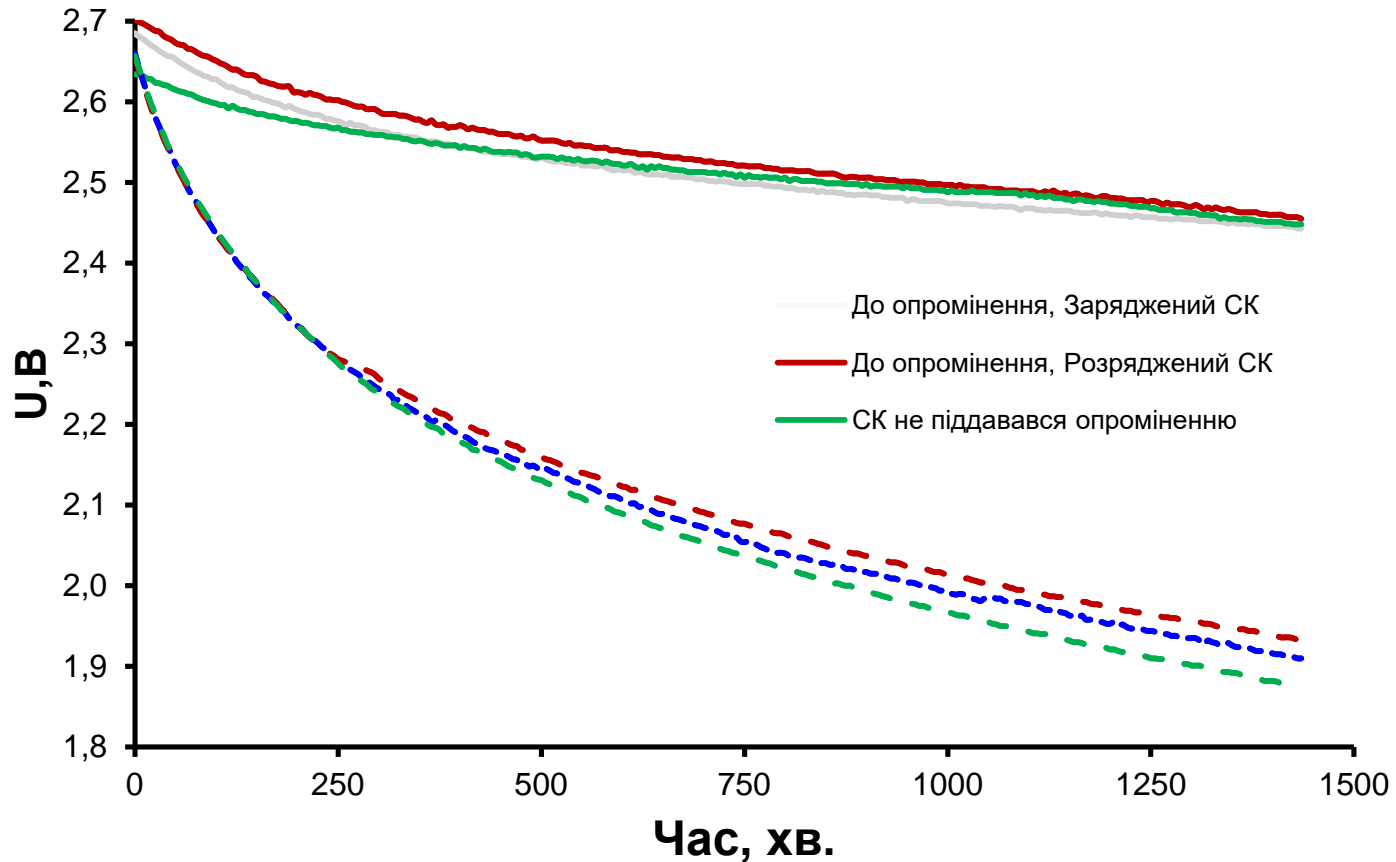

Fig. 6

Output of the diode laser after irradiation by gamma radiation

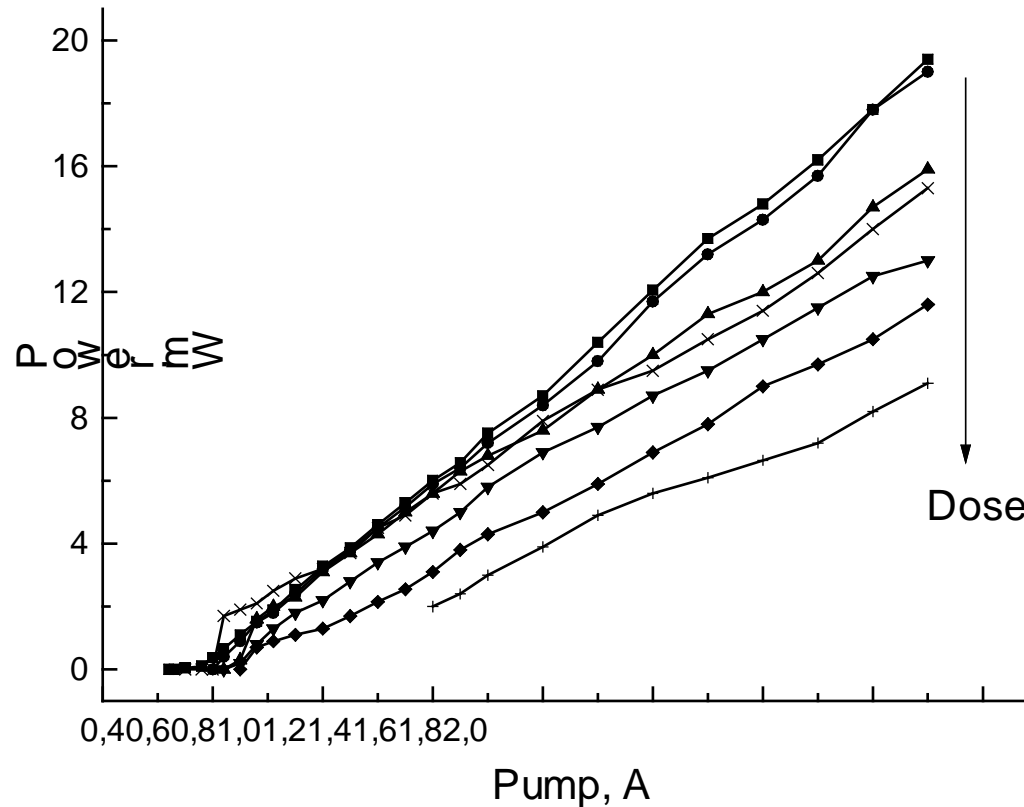

Fig. 7

Transmission of Nd YAG crystal plate

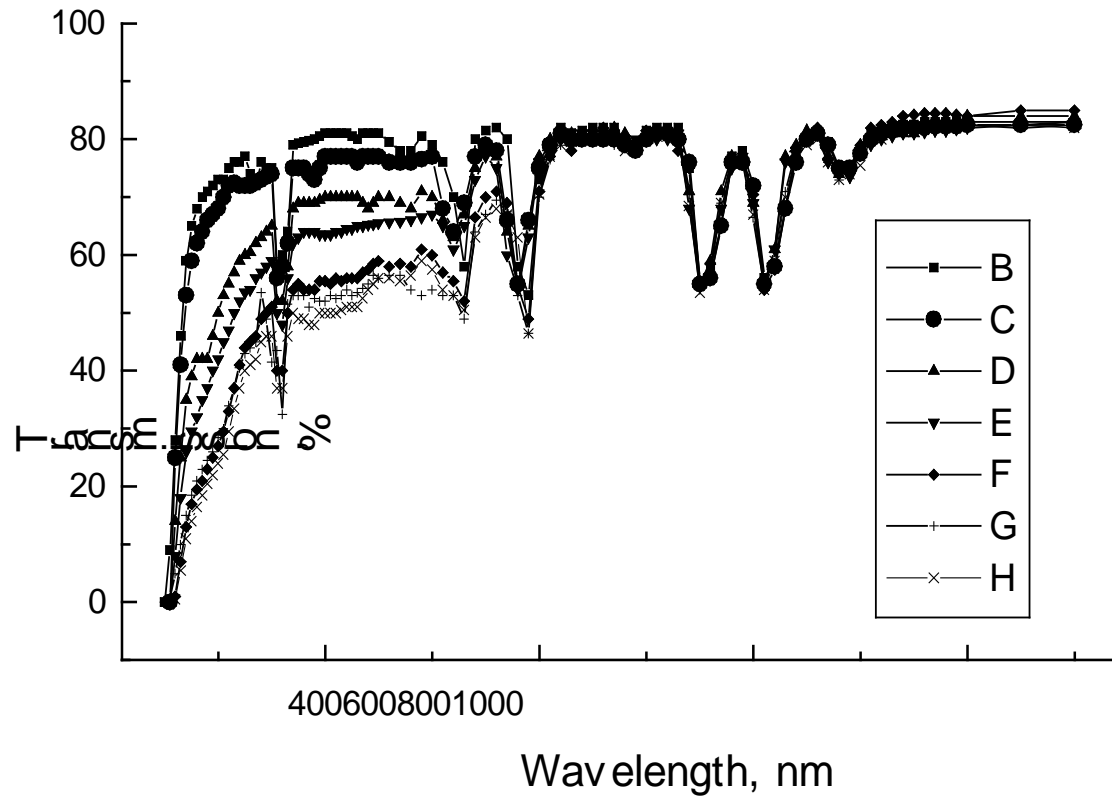

Fig. 8

Conclusions

- The following models have been proposed:
 - (a) solar wind influences on devices;
 - (b) forecasting of ionizing radiation;
 - (c) risk assessment in safety analysis.
- An application of the multicriterion optimization method to the prediction of the geomagnetic indexes. Novel algorithms to the identification of discrete input-output models have been developed.

Conclusions (cont'd)

- Energetic electrons within the inner magnetosphere can cause both deep and surface charging of spacecraft operating at GEO and MEO orbits. **Reliable forecast of the fluences of these electrons can assist in the mitigation of undesirable effects on spacecraft.** Previous forecasts of these fluences exploited either system science or first
- The first, system science approach provides accurate forecasts of electron fluxes but is limited to regions in which continuous data are available, i.e. GEO.